



CT30 LOCKS

Integra CT30 locks provide access control in any facility. The rugged and durable electronic locks are available as standalone models for quick, wireless installation. Modular hardware components and upgradeable reader technologies enable facility managers to upgrade on any scale, at any time. Easy to install and operate, CT30 locks are built for today and ready for tomorrow.

USER BENEFITS

UPGRADEABLE TECHNOLOGIES

CT30 locks meet your needs now and in the future with exchangeable reader technologies. RFID readers handle MIFARE Classic®, MIFARE Plus®, and MIFARE® DESFire® EV1 technologies; and can share cards with other facility systems. Keypad-only access is especially suitable for common access areas. Supplement your RFID or magnetic stripe readers with a keypad for Card-plus-PIN applications.

MODULAR ARCHITECTURE

Match your hardware configuration to your needs with a variety of finishes, handle styles, and escutcheons. Lock cases in mortise, cylinder or mortise-with-deadbolt may be ordered with key overrides for emergency use. Thumb-turn deadbolts are available. Wall-mounted readers or keypads are especially useful for high-traffic perimeter doors.

VERSATILE AND SECURE MANAGEMENT OPTIONS

Read and program CT30 locks with an Integra portable programmer, or choose online control with a CT30 wall reader connected to your Ethernet. Locks accommodate accuracy and security with deadbolts and latches that retract in one motion when the handle is engaged from the inside. A record is stored in the audit trail when emergency key override is used. LEDs indicate lock status and low battery conditions.

COST EFFECTIVE INSTALLATION AND MAINTENANCE

CT30 locks and the Integra system deliver value now and in the future. Installation is quick with no hardwiring required, operations are straightforward with Integra dedicated software, rugged hardware is long-lived and can be protected with extended warranty, and exchangeable technologies make today's investment work in tomorrow's landscape.

KEY FEATURES

- Exchangeable technology provides path for future upgrades
- Modular architecture ensures versatility and flexibility
- Standalone locks eliminate need for wired power or network communications
- Rugged and durable for long-lasting performance
- ANSI Grade 1 certified, mortise version

Lock hardware and configuration options

Reader technologies

	RFID
	RFID+Keypad
	Magnetic Stripe
	Magnetic Stripe+Keypad
	Keypad only

Lock cases

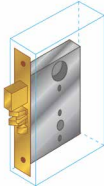
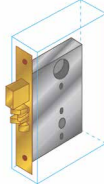
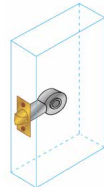
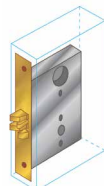

Mortise with Deadbolt	ANSI standard mortise lock with 1 in. (25.4mm) deadbolt that may be projected from either side of the door. 3/4 in. (19.05mm) latch.	
Mortise with Deadbolt (AFC version available)	AFC (Alternative Fire Code) version mortise lock uses automatic and manual operation to secure the lock. Latch monitoring confirms door is secure.	
Cylindrical	UL approved latch installs in a standard prep for a cylindrical latch. Standard square-cornered 1/2 in. (12.70mm) latch. Bored Lock Adaptor Heavy Grade cylindrical lock attachment used with cylindrical lockset. 1-3/8 or 1-3/4 in. (34.925 or 44.45mm) door thickness only. Backsets available: 2-3/8, 2-3/4, 3-3/4 or 5 in. (60.325, 69.85, 95.25, 127mm).	
Mortise, Latch Only	ANSI standard mortise lock without deadbolt 3/4 in. (19.05mm) latch. Narrow 2-1/2 in. (63.5mm) front or backset mortise lock case is available upon request.	

Escutcheons

Standard	RFID or Magstripe	
Keypad	RFID or Magstripe	
Emergency key override*	RFID or Magstripe	

*Customer provides key cylinder, 1" length with Adams Rite cam.

Levers

Toledo	Standard outside lever with 1/2 in. (12.7mm) return and inside lever	
Granada		

Finish**

	626 satin chrome
---	------------------

**Contact Onity for additional finishes

Strike Plates

Standard mortise***	4-7/8 in. (123.83mm)	
	8 in. (203.2mm)	
	10 in. (254mm)	
	12 in. (304.80mm)	
Latch-only mortise	4-7/8 in. (123.83mm)	
	8 in. (203.2mm)	
	10 in. (254mm)	
Cylindrical	2-3/4 in. (69.85mm)	
	4-7/8 in. (123.83mm)	

***Contact Onity for custom sizes

Cover Plates

	5 x 13-1/4 in. (127 x 336.55mm)
	5 x 18 in. (127 x 457.2mm)

Face Plates

	Standard, Latch-only
---	-------------------------

Wrap Plates

	Available
---	-----------

Rim Panic Interface (does not include lock or bar)

Compatible	K2 Series, QED100 Rim Panic	
	Von Duprin 98/99 Series Rim Panic	
Regulatory	ANSI Grade 1, ADA compliant, UL (power), UL (fire) available upon request	

Lock Modes

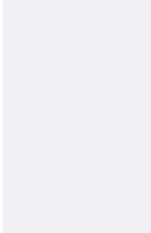
	Keycard only
	Keypad only
	Keycard plus PIN
	Office first
	Office
Security passage	

Specifications

Regulatory

UL & ULC listed lock cases for installation on fire doors
ADA compliant
AFC compliant
ANSI Grade 1 mortise version

Physical Description

Outside dimensions escutcheon only	3.13 x 9.5 x 1.81 in. (80 x 241 x 46mm) escutcheon only
Outside dimensions with lever	6.56 x 9.5 x 3.13 in. (167 x 241 x 80mm)
Weight	Mortise 9.5 lb. (4.3kg) Cylindrical 7.8 lb. (3.5kg)

Compatibility

Keycards	High and low coercivity standard ISO/ABA mag-stripe cards
RFID smartcards	MIFARE Classic®, MIFARE Plus®, MIFARE® DESFire® EV1

Capacity

Up to 3000 users per door with 448 events in the audit trail
Non-volatile memory stores up to the last 1184 events and 1500 users, including rejections, in the audit trail

Power

Batteries	4 standard alkaline 1.5 volt batteries
	Lithium batteries are used for some outdoor applications
Standby Mode	20 µA
	Low-consumption clock/calendar controls card shifts/timetables

Environmental Tolerance

Temperature	32-149°F / 0-65°C standard; 40-167°F (-40-75°C) for lithium batteries
Humidity	Up to 95% without condensation



Onity Inc.
4001 Fairview Industrial Drive SE
Salem, OR 97302

©2018 Onity Inc. All rights reserved. Onity is a part of UTC Climate, Controls & Security, a unit of United Technologies Corporation.

MIFARE®, MIFARE Classic®, MIFARE Plus®, and DESFire® are registered trademarks of NXP B.V. Other brand and product names are or may be the trademarks of, and are used to identify products or services of, their respective owners.

11/2018 (GSP-2781)

Regulatory

Certifications

CE, FCC, and ISED certified

FCC ID: R32-10103704P1

IC: 5058A-10103704P1

Model Numbers

CT30 Lock, Regulatory Model Number (RMN)	10104741P1
CT30 Lock, Commercial Model Number (CMN)	10104745P1
CT30 Lock with Keypad, Regulatory Model Number (RMN)	10104741P1
CT30 Lock with Keypad, Commercial Model Number (CMN)	10104746P1

Certification Statements

United States (FCC)

This device complies with part 15 of the FCC rules. Operation is subject to the following conditions:

1. This device may not cause harmful interference.
2. This device must accept any interference received, including interference that may cause undesired operation.

Changes or modifications not expressly approved by the party responsible for compliance could void the user's authority to operate the equipment.

Canada (IC)

This device complies with Industry Canada's license-exempt RSSs. Operation is subject to the following two conditions:

- (1) This device may not cause interference; and
- (2) This device must accept any interference, including interference that may cause undesired operation of the device.

Cet équipement est conforme à la (aux) norme(s) canadienne(s) d'exemption de licence RSS Industry Canada. Son opération est sujette aux deux conditions suivantes: (1) cet équipement ne provoquera aucune interference et (2) cet équipement doit tolérer toute in interference pouvant provoquer une opération indésirable de l'équipement.

European Union (CE)

This Class B digital apparatus conforms to the requirements of the following EU directives:

1. RED 13.56 MHz \pm 7 kHz. 13.7 dBuV/m@30m
2. WEEE Directive (2012/19/EC)

Onity Inc.
4001 Fairview Industrial Drive SE
Salem, OR 97302

©2018 Onity Inc. All rights reserved. Onity is a part of UTC Climate, Controls & Security, a unit of United Technologies Corporation.

MIFARE®, MIFARE Classic®, MIFARE Plus®, and DESFire® are registered trademarks of NXP B.V. Other brand and product names are or may be the trademarks of, and are used to identify products or services of, their respective owners.

11/2018 (GSP-2781)